

# boomchair<sup>®</sup>

experience the ultimate level  
of gaming and music

# WFO

wireless  
ready option

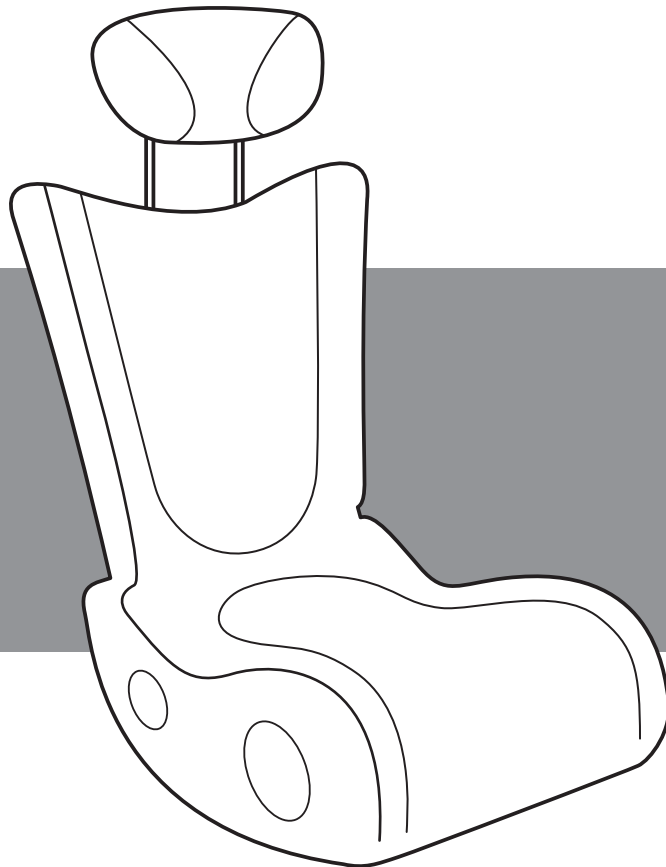

# boomchair®

Congratulations!

You are now the proud owner of a BOOMCHAIR®. Prepare to experience your entertainment on a whole new level. BOOMCHAIR® allows you to HEAR the sound and FEEL the excitement. You'll experience every crash, bang, and boom while enjoying your favorite game, music, or movie. BOOMCHAIR® is also a great game seat built to endure the rigors of today's gaming environment. Take a moment to review your owner's manual before connecting your BOOMCHAIR®. Assembly and operation of the BOOMCHAIR® is simple.

If you need further assistance visit us at [www.BoomChair.com](http://www.BoomChair.com) or [www.LumiSource.com](http://www.LumiSource.com)

BOOMCHAIR®, a LumiSource® product.  
LumiSource, LLC  
2950 Old Higgins Road, Elk Grove Village, IL 60007

PATENTS PENDING

## CAUTIONS

### READ BEFORE USE

- DO NOT wash or soak with water. If BOOMCHAIR® gets wet, disconnect power immediately and do not use until completely dry.
- Turn power off and unplug BOOMCHAIR® when not in use.
- Children under 5 years old should not use this product without parental supervision.
- For INDOOR use only/ DO NOT expose to direct sunlight, moisture, or extreme temperatures.
- DO NOT use on slippery or uneven flooring.
- DO NOT use on wood flooring, it may cause scratching.
- DO NOT Mix Old And New Batteries. Do Not Mix Alkaline, Standard (Carbon - Zinc), Or Rechargeable (Nickel - Cadmium) Batteries.
- To avoid explosion or leakage, do not dispose of batteries in a fire or attempt to recharge standard or alkaline batteries. Please dispose of batteries safely according to the battery manufacturers instructions or recycle battery per state and local codes. If battery leakage occurs and comes in contact with the skin or eyes, wash immediately with plenty of water. Batteries should be handled under adult supervision. If the device is not to be used for a long period of time, remove the batteries to prevent injury from possible battery leakage.
- Excessive exposure to audio equipment at high volume may lead to hearing loss.
- DO NOT TAMPER WITH OR OPEN

Caution: To reduce the risk of electric shock and fire, do not open the BOOMCHAIR®. There are no user serviceable parts inside. Refer to your warranty for service information.



*Internal*

### FCC part 15.21:

Warning: Changes or modifications to this unit not expressly approved by the party responsible for compliance could void the user's authority to operate the equipment.

### FCC WARNING

This device complies with Part 15 of the FCC rules.

Operation is subject to the following two conditions:

- (1) This device may not cause harmful interference.
- (2) This device must accept any interference received, including interference that may cause undesired operation.

## SET-UP GUIDE

The BOOMCHAIR® comes with the following:

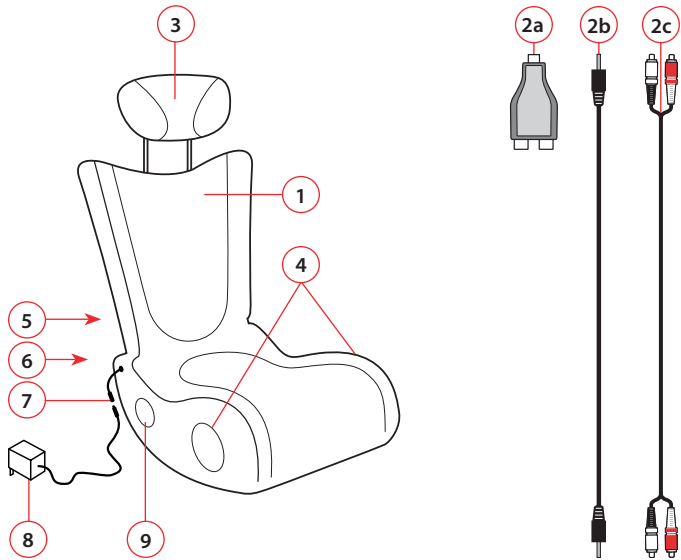

### PARTS LIST:

- 1) UFO BOOMCHAIR®
- 2a) RCA Y-AUDIO ADAPTOR
- 2b) AUDIO CORD
- 2c) RCA CORD (audio left & right channel connectors)
- 3) ADJUSTABLE HEADREST
- 4) SPEAKERS
- 5) HOOK & LOOP FASTENER
- 6) ADJUSTABLE RECLINE STOPPERS
- 7) POWER RECEPTACLE
- 8) 12V POWER ADAPTOR
- 9) DASHBOARD CONTROL PANEL

### Wireless

- W1) WIRELESS TRANSMITTER  
 (4 AA BATTERIES REQUIRED, NOT INCLUDED)

### Wireless Transmitter

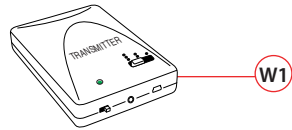

### SYSTEM SPECS:

Dimensions: 24 in. L x 18 in. W x 36 in. H  
 61 cm. L x 46 cm. W x 92 cm. H  
 2 x 3 in. (7.5 cm) coaxial mid-high speakers @ 3W 4 Ohms  
 4 in. (10 cm) sub-woofer speakers @ 15W 4 Ohms

## DASHBOARD CONTROL PANEL

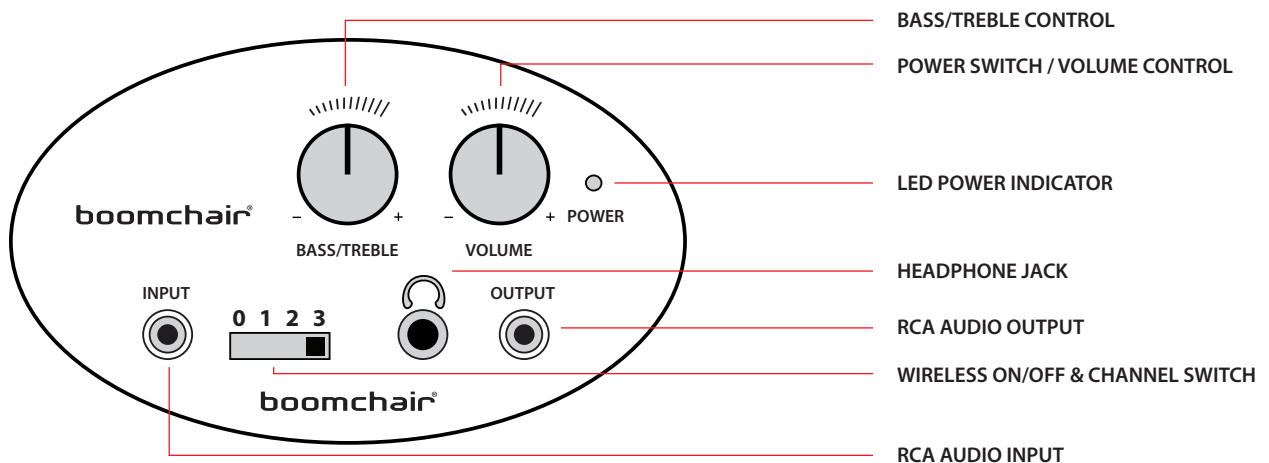

## ASSEMBLY INSTRUCTIONS

- Step 1: Secure the seat back using attached HOOK & LOOK FASTENER (5).
- Step 2: Insert ADJUSTABLE HEADREST (3) into BOOMCHAIR® (1).
- Step 3: Insert 12V POWER ADAPTOR (8) into the POWER RECEPTACLE (7).
- Step 4: Plug 12V POWER ADAPTOR (8) into power outlet.\*
- Step 5: Turn BOOMCHAIR® (1) on by turning POWER SWITCH/VOLUME CONTROL clockwise.

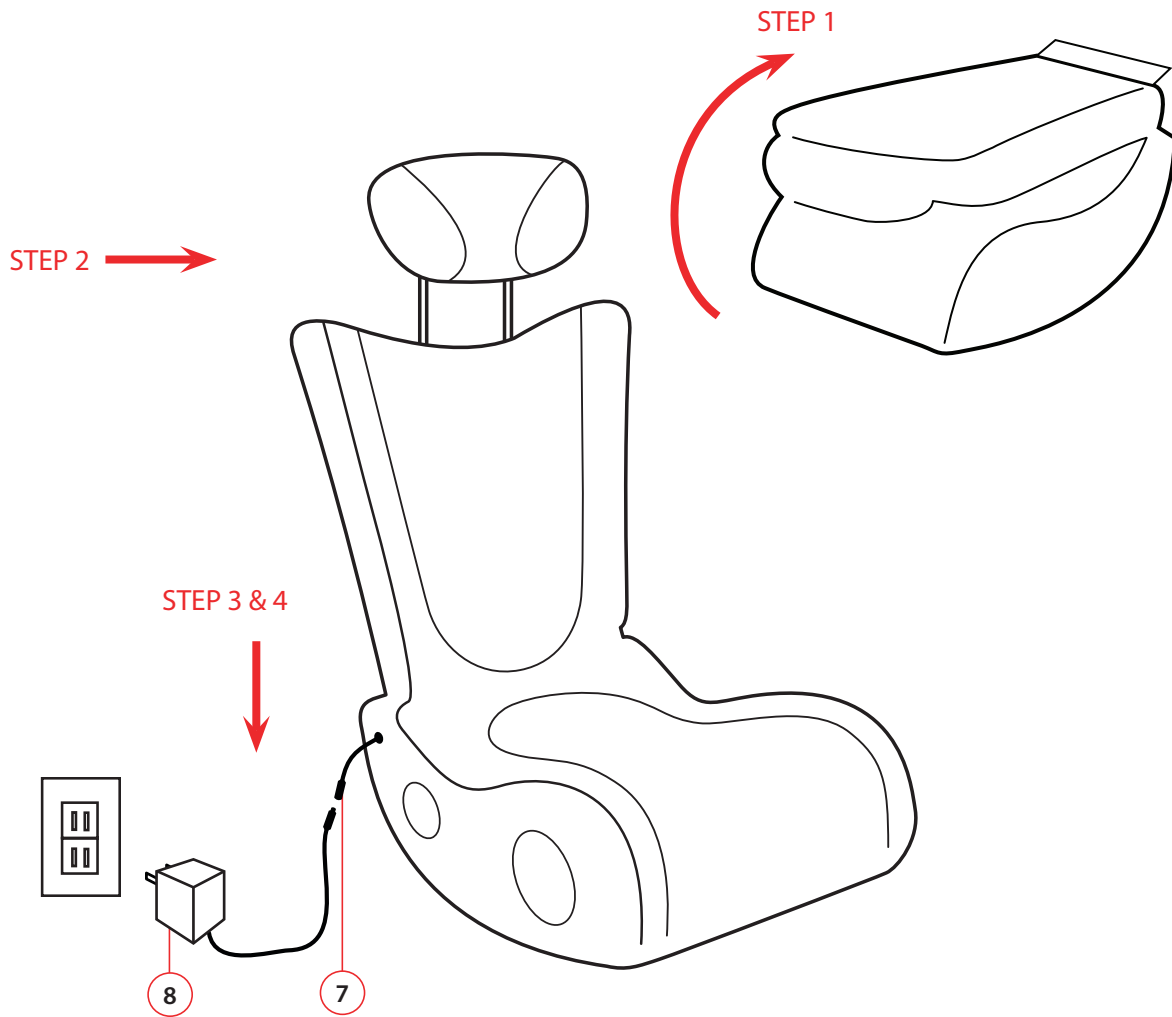

*\*CAUTION: Use only provided adaptor! Different voltage may cause permanent damage.*

# CONNECTING YOUR GAMES, MUSIC AND MOVIES

## DIRECT CONNECTION

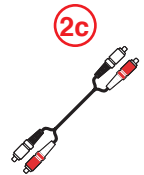
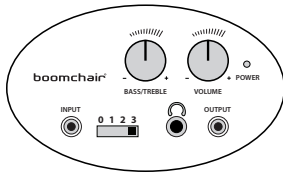

### 1 CONNECTING GAME CONSOLES

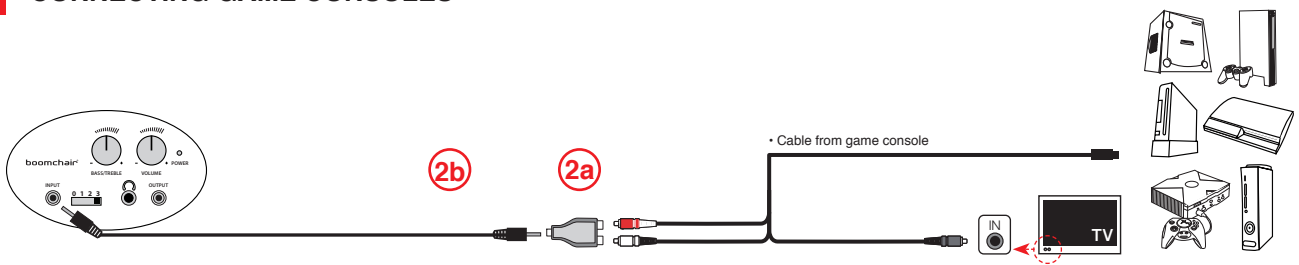

### 2 CONNECTING TV / DVD

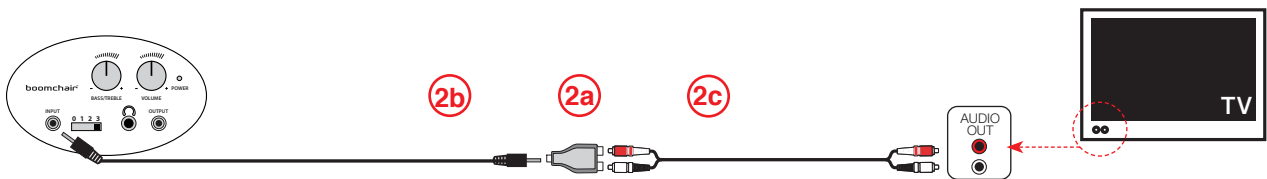

### 3 CONNECTING HANDHELD / MP3 / PORTABLE DEVICES



### 4 CONNECTING WHILE USING YOUR HDMI CABLE

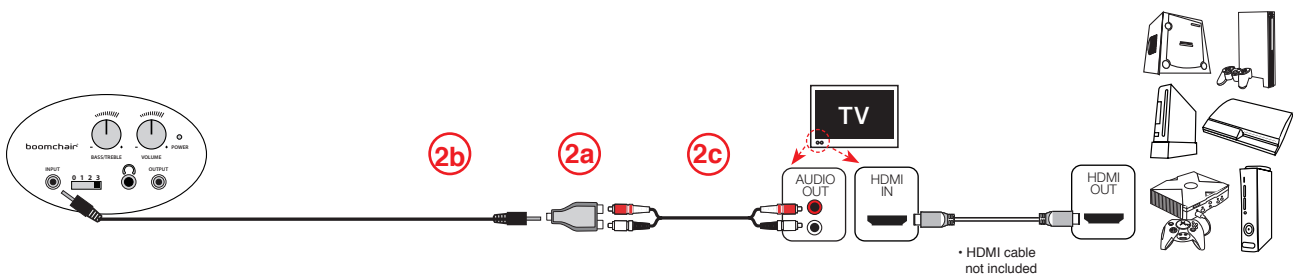

# CONNECTING YOUR GAMES, MUSIC AND MOVIES

## WIRELESS CONNECTION

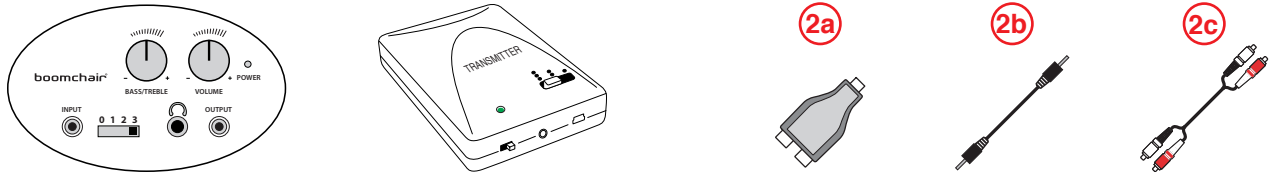

### 1 CONNECTING GAME CONSOLES

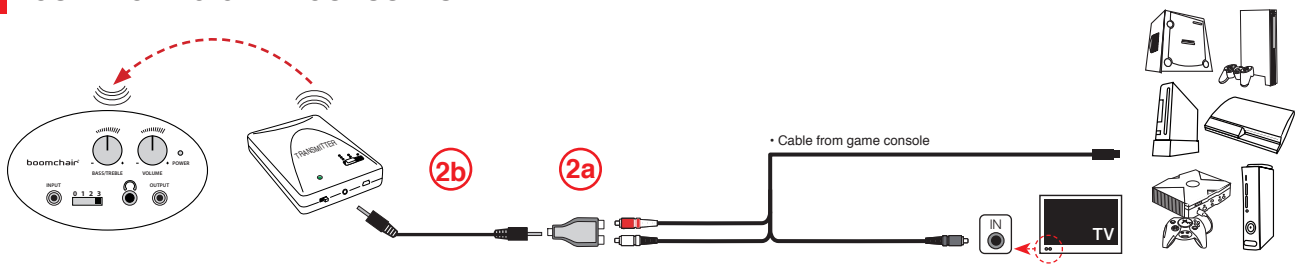

### 2 CONNECTING TV / DVD

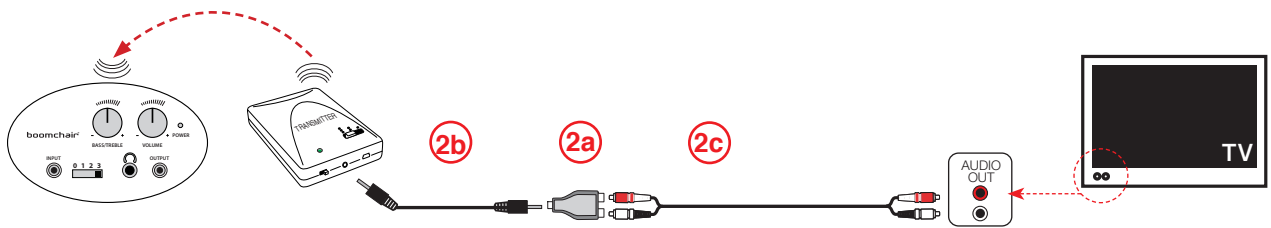

### 3 CONNECTING HANDHELD / MP3 / PORTABLE DEVICES



### 4 CONNECTING WHILE USING YOUR HDMI CABLE

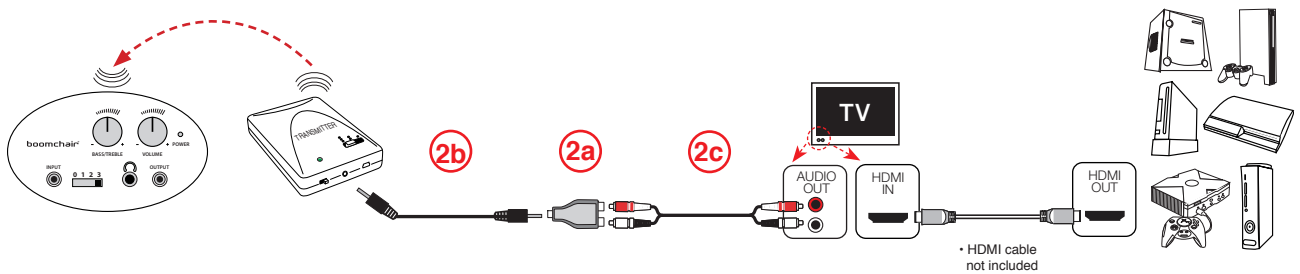

## WIRELESS CONNECTION TIPS

Should interference occur, switch the channel on the WIRELESS TRANSMITTER & DASHBOARD CONTROL PANEL to a corresponding number of dots using the top slider bar (Fig. 1). Confirm that all cables are securely connected.

Make sure 4 AA batteries are correctly installed in the WIRELESS TRANSMITTER and that the power is on, as indicated by the LED (Fig. 2).

If you experience static or poor reception from your wireless connection, you may need to select the direct connection method to ensure the best possible sound quality.

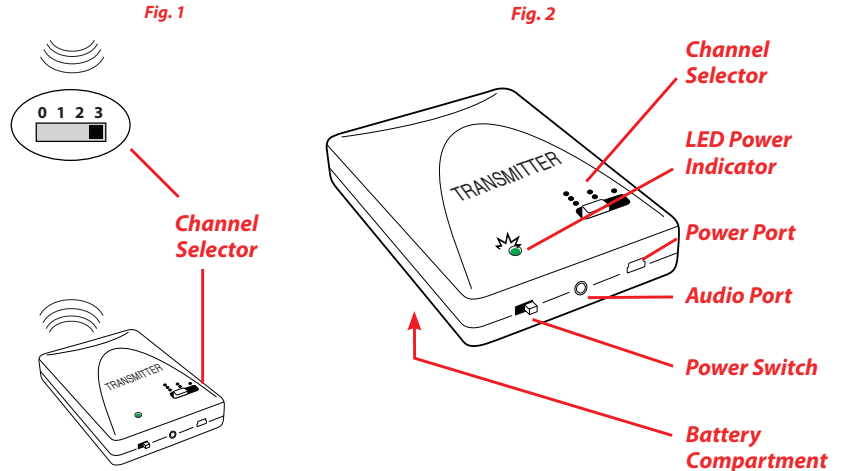

## DAISY CHAINING CHAIRS TOGETHER

### DIRECT CONNECTION

- Step 1: Connect first BOOMCHAIR® to any media device using the Direct Connection method as described on page 5.
- Step 2: Connect one end of 1/8 in. (3.5mm) AUDIO CORD (2b) into OUTPUT of first BOOMCHAIR®.
- Step 3: Connect other end of 1/8 in. (3.5mm) AUDIO CORD (2b) into INPUT of second BOOMCHAIR®.
- Step 4: Repeat steps 2 and 3 starting from second chair to connect more BOOMCHAIRS®.
- Step 5: Turn all BOOMCHAIRS® on by turning POWER SWITCH / VOLUME CONTROL clockwise.

Up to 4 BOOMCHAIRS® can be connected when using the direct connection method.

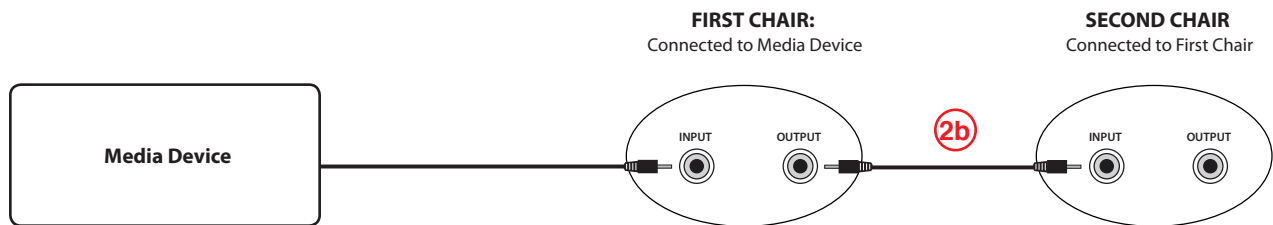

### WIRELESS CONNECTION

- Step 1: Connect BOOMCHAIR® to any media device using the Wireless Method as described on page 6.
- Step 2: Repeat Steps 2 through 4 of the Direct Connection method to connect more BOOMCHAIRS®. OR, if using wirelessly, change the wireless number of every BOOMCHAIR® to the corresponding number of dots on the Transmitter.
- Step 3: Turn all BOOMCHAIRS® on by turning POWER SWITCH / VOLUME CONTROL clockwise.

Up to 4 BOOMCHAIRS® can be connected using the wireless method.

## TROUBLESHOOTING BOOMCHAIR®

Q: Why isn't there sound coming from any of my speakers?

A: Ensure your BoomChair® is connected as described in the Assembly Instructions. Check that the power to the unit is on and the volume is turned up. Make sure your audio device is not set to "MUTE" and volume is turned up.

Q: Where can I get more information?

A: Visit us at [www.BoomChair.com](http://www.BoomChair.com) or [www.LumiSource.com](http://www.LumiSource.com) Contact information: LumiSource, LLC. 2950 Old Higgins Road, Elk Grove Village, IL 60007, E-mail: [customerservice@lumisource.com](mailto:customerservice@lumisource.com)

## MAINTENANCE/REPAIR & CLEANING/CARE INSTRUCTIONS

If a problem occurs while using this product, please contact [customerservice@lumisource.com](mailto:customerservice@lumisource.com). DO NOT open unit or attempt to repair on your own. It may result in serious injury from electric shock and void your product warranty.

Fabric: Use a clean cloth to dab lightly with soap and water. DO NOT rub. DO NOT immerse in water. DO NOT use detergent.

**NOTE: PLEASE DO NOT USE ON HARDWOOD FLOORS, IT MAY CAUSE SCRATCHING.**

## LUMISOURCE, LLC LIMITED WARRANTY

**LIMITED WARRANTY:** LumiSource, LLC ("LumiSource") warrants this product against defects in materials and workmanship for a period of ninety (90) days from the date of original consumer purchase. If a covered warranty claim is timely made, LumiSource, LLC will, at its sole discretion: (a) repair the product, using new and/or refurbished replacement parts or (b) replace the product with an identical (or comparable) product, without charge to you other than the initial shipping cost to return the product. LumiSource, LLC will only pay return shipping charges for destinations within the 48 contiguous U.S.A., if the returned product is covered by the limited warranty.

**WHAT THIS WARRANTY DOES NOT COVER:** This warranty does not cover defects resulting from accidents, alterations, unauthorized repair, failure to follow instructions, misuse, commercial use, fire, flood, or acts of God.

**WHAT WE ASK YOU TO DO:** If there is a covered defect, please write or email us within 90 days of the date of purchase at the address noted below to obtain instructions and authorization to return the product to LumiSource, LLC. You will need to pack the product securely in packaging providing at least the degree of protection of the original carton and packing materials and ship it to us at your expense. You will also need to include with the product (a) a copy of your original proof of purchase (retail receipt) showing the date of purchase and (b) a detailed explanation of the problem(s) requiring service.

TO THE EXTENT PERMITTED BY LAW, THIS LIMITED WARRANTY AND THE REMEDIES SET FORTH ABOVE ARE EXCLUSIVE AND IN LIEU OF ALL OTHER WARRANTIES, REMEDIES AND CONDITIONS, ORAL OR WRITTEN, EXPRESS OR IMPLIED. TO THE EXTENT PERMITTED BY LAW, LUMISOURCE, LLC HEREBY DISCLAIMS ANY IMPLIED WARRANTIES, INCLUDING WITHOUT LIMITATION, WARRANTIES OF MERCHANTABILITY AND FITNESS FOR A PARTICULAR PURPOSE. TO THE EXTENT APPLICABLE STATE LAW EXCLUDES SUCH DISCLAIMERS, THEN TO THE EXTENT ALLOWED BY LAW, THE TIME FOR ANY CLAIMS FOR SUCH IMPLIED WARRANTIES SHALL EXPIRE 90 DAYS FROM THE DATE OF ORIGINAL CONSUMER PURCHASE. TO THE EXTENT PERMITTED BY LAW, LUMISOURCE, LLC IS NOT RESPONSIBLE FOR DIRECT, SPECIAL, INCIDENTAL OR CONSEQUENTIAL DAMAGES, INCLUDING BUT NOT LIMITED TO LOSS OF TIME, INCONVENIENCE, LOSS OF USE OF YOUR PRODUCT, OR PERSONAL INJURY OR PROPERTY DAMAGE, CAUSED BY YOUR PRODUCT OR ITS FAILURE TO WORK.

This limited warranty gives you specific legal rights. Some states do not allow the exclusion or limitation of incidental or consequential damages, and applicable law may not permit the exclusion of certain implied warranties. You may also have other rights, which vary, from state to state.

LumiSource, LLC

2950 Old Higgins Road, Elk Grove Village, IL 60007

E-mail: [customerservice@lumisource.com](mailto:customerservice@lumisource.com)

Phone: 1-888-461-5864 (toll free)

Phone: 1-847-699-8988 (international)

[www.BoomChair.com](http://www.BoomChair.com) • [www.LumiSource.com](http://www.LumiSource.com)

© 2011 LumiSource, LLC. All rights reserved. BoomChair® UFO and the BoomChair® logo are trademarks of LumiSource, LLC. Other trademarks are properties of their respective owners. The design of this product is a trade dress of LumiSource, LLC. Patents pending. Actual contents may differ slightly from those pictured. Made in China. Distributed by LumiSource, LLC, 2950 Old Higgins Road, Elk Grove Village, IL 60007. [www.lumisource.com](http://www.lumisource.com).

This product is not manufactured or distributed by Microsoft® the owner of the trademark Xbox™. This product is not manufactured or distributed by Nintendo® the owner of the trademark GameCube™ and DS™. This product is not manufactured or distributed by Sony® the owner of the trademark Playstation™ PS3™, PS2™, and PSP™. iPod™ is a registered trademark of Apple Computer, Inc. All Rights Reserved.